

# WL2836D

**Low noise, High PSRR, High speed, CMOS LDO**

[Http://www.ovt.com](http://www.ovt.com)

## Descriptions

The WL2836D series is a high accuracy, low noise, high speed, high PSRR, low dropout CMOS Linear regulator with high ripple rejection. The devices offer a new level of cost effective performance in cellular phones, laptop and notebook computers, and other portable devices.

The WL2836D has the fold-back maximum output current which depends on the output voltage. So the current limit functions both as a short circuit protection and as an output current limiter.

The WL2836D regulators are available in standard DFN1x1-4L Package. Standard products are Pb-free and Halogen-free.

## Features

- Input Voltage Range : 1.4V~5.5V
- Output Voltage Range : 0.9V~3.3V
- Output current : 300mA
- Quiescent current : 50µA Typ.
- Shut-down current : < 1µA
- Dropout voltage : 140mV @ I<sub>OUT</sub>=0.3A
- PSRR : 78dB @ 1kHz, V<sub>OUT</sub>=1.8V
- Low Output Voltage Noise : 13×V<sub>OUT</sub> µV<sub>RMS</sub>
- Output Voltage Tolerance : ±1% @ V<sub>OUT</sub>>2V
- Recommend capacitor : 1µF
- Thermal-Overload and Short-Circuit Protection

## Applications

- MP3/MP4 Players
- Cellphones, radiophone, digital cameras
- Bluetooth, wireless handsets
- Others portable electronics device



DFN1x1-4L

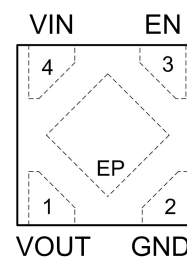

## Pin Configuration (Top View)

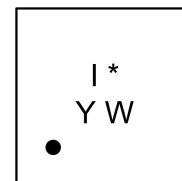

**I** : Device Code  
**\*** : Voltage Code  
**Y** : Year Code  
**W** : Week Code

For detail marking information, please see page 14.

## Marking

## Order Information

For detail order information, please see page 14.

Typical Application

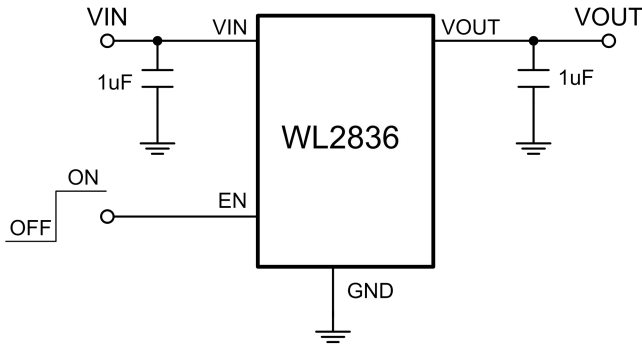

Pin Description

DFN1x1-4L

PIN	Symbol	Description
1	V <sub>OUT</sub>	Output
2	GND	Ground
3	EN	Enable (Active high)
4	V <sub>IN</sub>	Input
EP		GND level, this pin must connect to GND.

Block Diagram

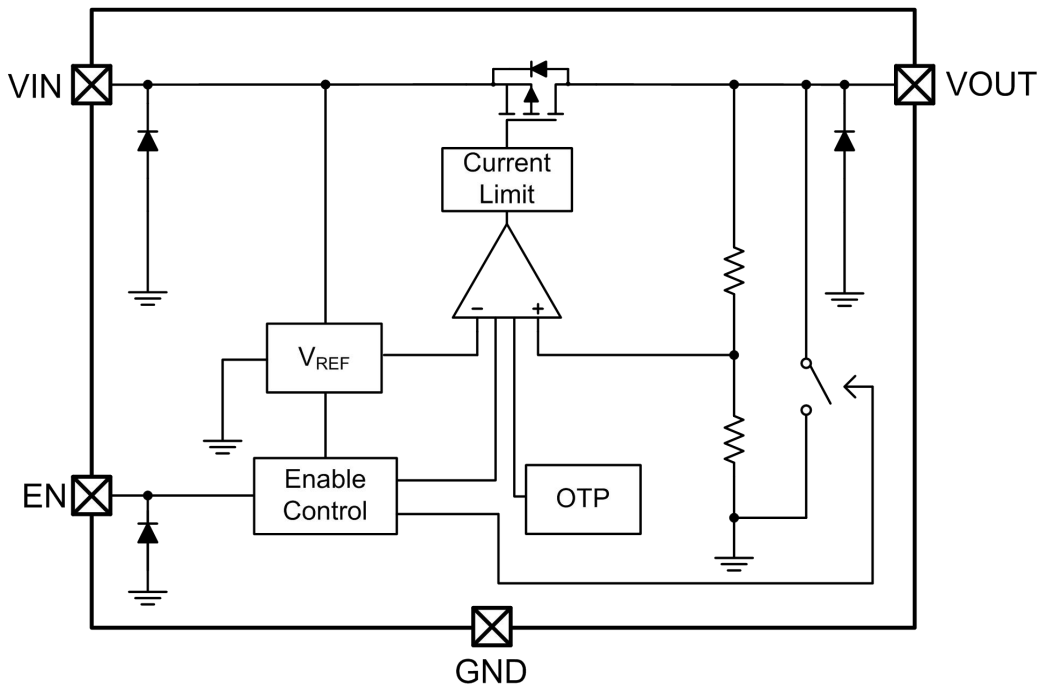

### Absolute Maximum Ratings

Parameter	Value	Unit	
Power Dissipation, $P_D@T_A=25^\circ\text{C}$	400	mW	
$V_{IN}$ Range	-0.3~6.5	V	
$V_{EN}$ Range	-0.3~ $V_{IN}$	V	
$V_{OUT}$ Range	-0.3~ $V_{IN}$	V	
$I_{OUT}$	Internally Limited		
Lead Temperature Range	260	°C	
Storage Temperature Range	-55 ~ 150	°C	
Operating Junction Temperature Range	150	°C	
MSL	Level-1		
ESD Ratings	HBM	7500	V
	MM	300	V

### Recommend Operating Ratings

Parameter	Value	Unit
Operating Supply voltage	1.4~5.5	V
Operating Temperature Range	-40~85	°C
Thermal Resistance, $R_{\theta JA}$ (DFN1x1-4L)	250	°C/W

**Electronics Characteristics**
**(Ta=25°C, V<sub>IN</sub>=V<sub>OUT</sub>+1V, C<sub>IN</sub>=C<sub>OUT</sub>=1 μ F, I<sub>OUT</sub>=1mA, unless otherwise noted)**

Parameter	Symbol	Condition	Min.	Typ.	Max.	Unit
Output Voltage	V <sub>OUT</sub>	V <sub>OUT</sub> ≤ 2V	-20	V <sub>OUT</sub>	+20	mV
		V <sub>OUT</sub> > 2V	0.99× V <sub>OUT</sub>	V <sub>OUT</sub>	1.01× V <sub>OUT</sub>	V
Input Voltage	V <sub>IN</sub>		1.4		5.5	V
Current Limit	I <sub>LIM</sub>	V <sub>EN</sub> =V <sub>IN</sub>	300			mA
Dropout Voltage	V <sub>DROP</sub>	V <sub>OUT</sub> =3.3V, I <sub>OUT</sub> =300mA		118	185	mV
		V <sub>OUT</sub> =3V, I <sub>OUT</sub> =300mA		122	192	
		V <sub>OUT</sub> =2.8V, I <sub>OUT</sub> =300mA		130	204	
		V <sub>OUT</sub> =2.5V, I <sub>OUT</sub> =300mA		140	220	
		V <sub>OUT</sub> =1.6V, I <sub>OUT</sub> =300mA		205	320	
		V <sub>OUT</sub> =1V, I <sub>OUT</sub> =300mA		370	555	
Line Regulation	ΔV <sub>LINE</sub>	V <sub>IN</sub> =V <sub>OUT</sub> +0.5V~5.5V		1	5	mV
Load Regulation	ΔV <sub>Load</sub>	I <sub>OUT</sub> =1~300mA		15	28	mV
Quiescent Current	I <sub>Q</sub>	V <sub>OUT</sub> =2.8V, I <sub>OUT</sub> =0		50	90	μA
Short Current	I <sub>SHORT</sub>	V <sub>EN</sub> =V <sub>IN</sub> , V <sub>OUT</sub> Short to GND		120		mA
Shut-down Current	I <sub>SHDN</sub>	V <sub>EN</sub> =0V			1.0	μA
Power Supply Rejection Rate	PSRR	V <sub>IN</sub> =(V <sub>OUT</sub> +1V) <sub>DC</sub> + 0.5V <sub>P-P</sub> I <sub>OUT</sub> =10mA, V <sub>OSET</sub> =1.8V	f=100Hz	80		dB
			f=1kHz	78		dB
			f=10kHz	65		dB
			f=100kHz	56		dB
			f=1MHz	43		dB
EN logic high voltage	V <sub>ENH</sub>	V <sub>IN</sub> =5.5V, I <sub>OUT</sub> =1mA	1			V
EN logic low voltage	V <sub>ENL</sub>	V <sub>IN</sub> =5.5V, V <sub>OUT</sub> =0V			0.4	V
EN Input Current	I <sub>EN</sub>	V <sub>EN</sub> = 0 to 5.5V		120		nA
Output Noise Voltage	e <sub>NO</sub>	10Hz to 100KHz, C <sub>OUT</sub> =1μF		13× V <sub>OUT</sub>		μV <sub>RMS</sub>
Thermal shutdown threshold	T <sub>SD</sub>			160		°C
Thermal shutdown hysteresis	Δ T <sub>SD</sub>			30		°C
Auto-discharge Nch Tr, ON Resistance	R <sub>LOW</sub>	V <sub>IN</sub> =4V, V <sub>CE</sub> =0V, V <sub>OUT</sub> =2.8V		120		Ω

Typical characteristics ( $T_a=25^\circ\text{C}$ ,  $V_{IN}=V_{OUT}+1\text{V}$ ,  $I_{OUT}=1\text{mA}$ ,  $C_{IN}=C_{OUT}=1\ \mu\text{F}$ , unless otherwise noted)

**$V_{OUT}=1.2\text{V}$**

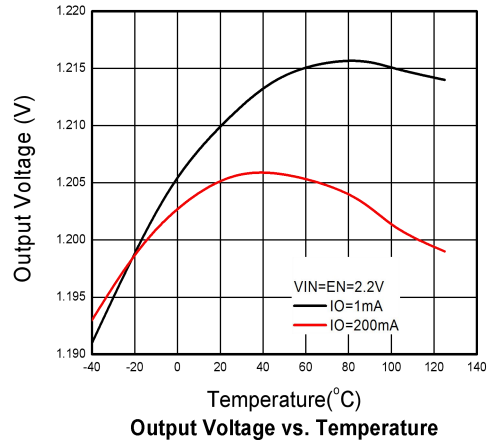
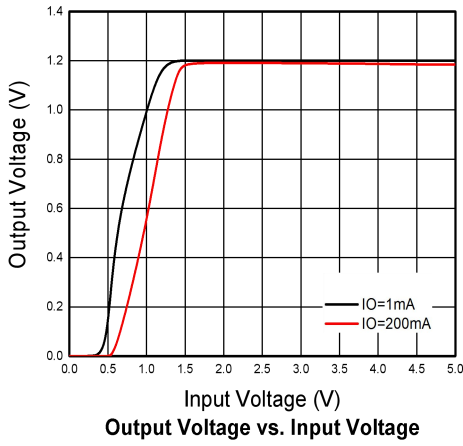

**$V_{OUT}=1.8\text{V}$**

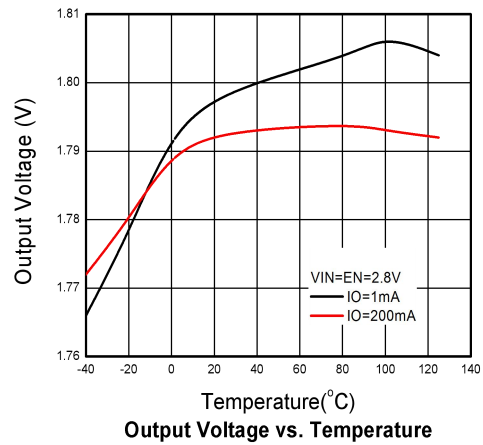
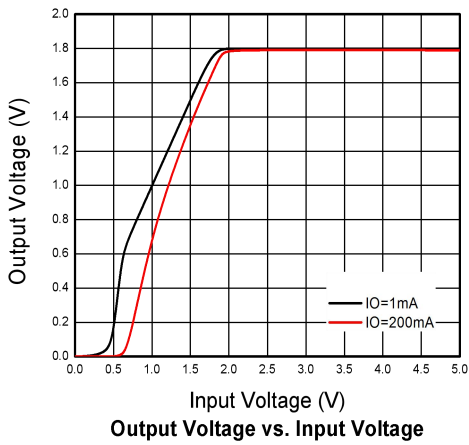

**$V_{OUT}=2.8\text{V}$**

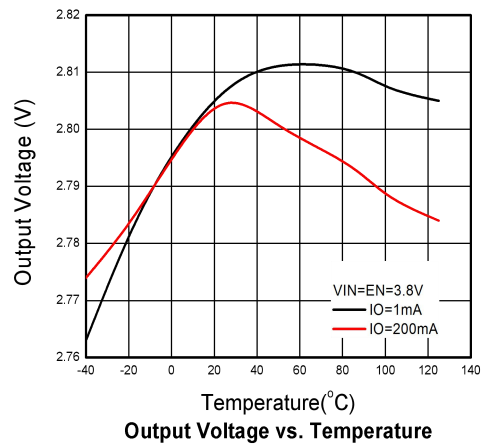
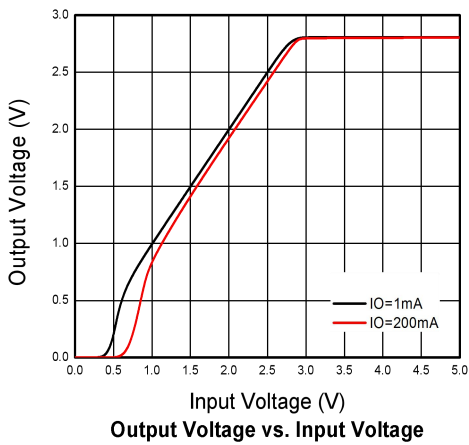

**V<sub>OUT</sub>=1.8V**

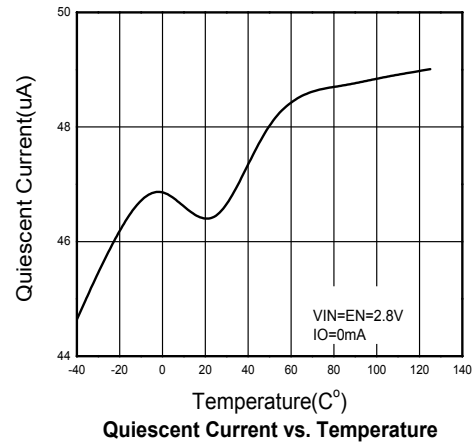
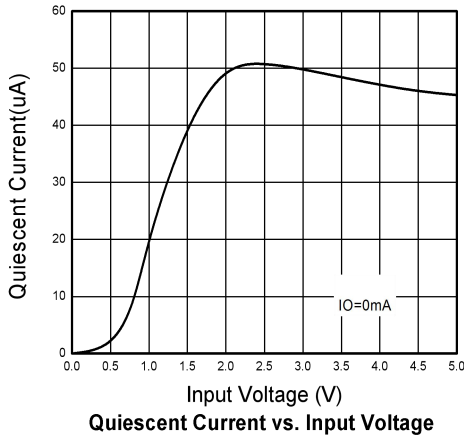

**V<sub>OUT</sub>=1.8V**

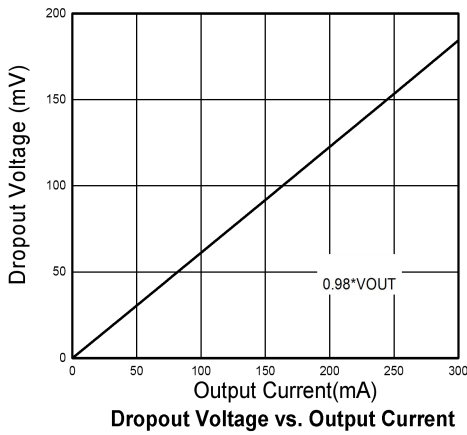

**V<sub>OUT</sub>=2.8V**

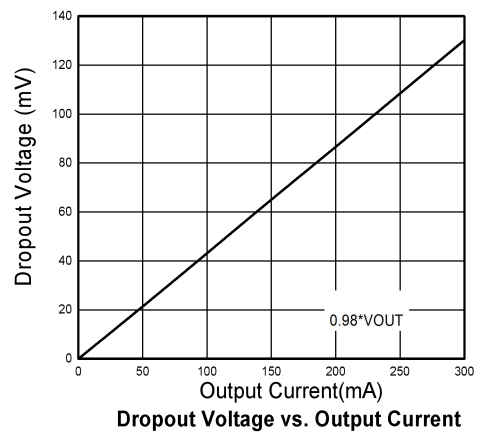

**V<sub>OUT</sub>=3.0V**

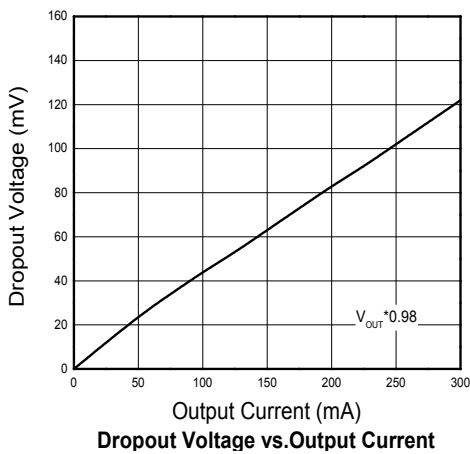

**V<sub>OUT</sub>=3.3V**

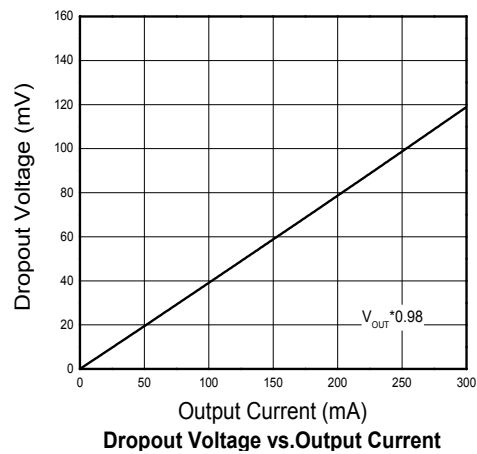

Vout=1.2V

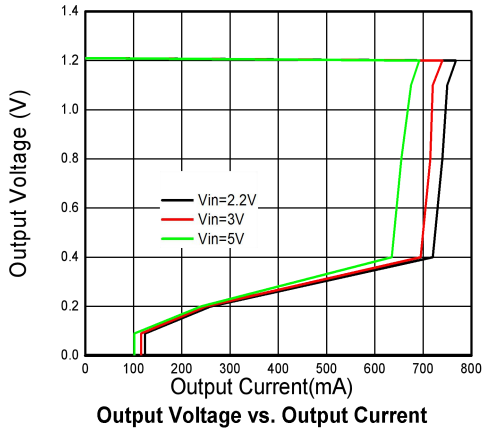

Vout=1.8V

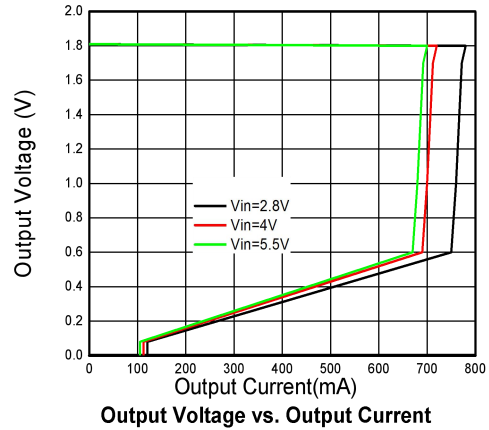

Vout=2.8V

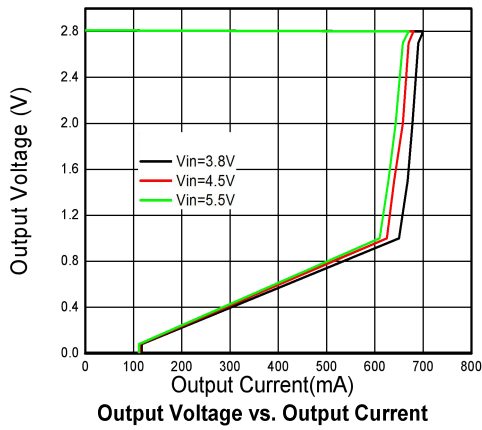

Vout=1.05V

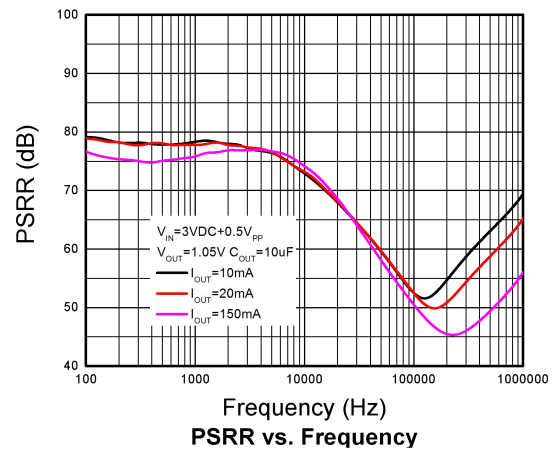
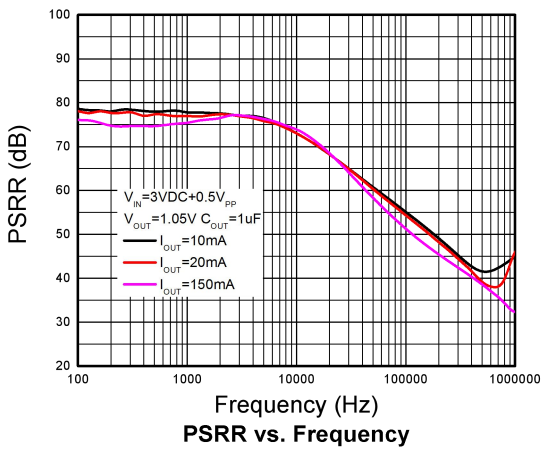

**V<sub>OUT</sub>=1.8V**

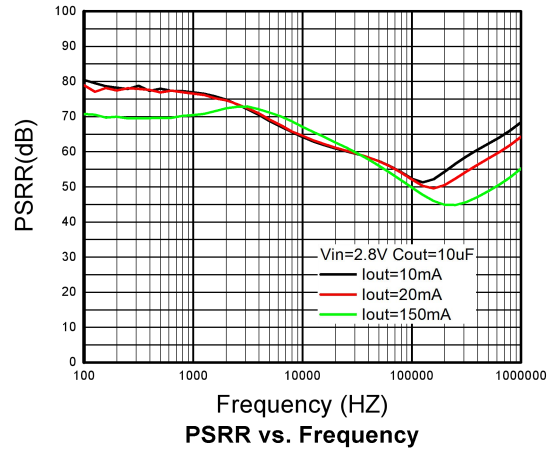
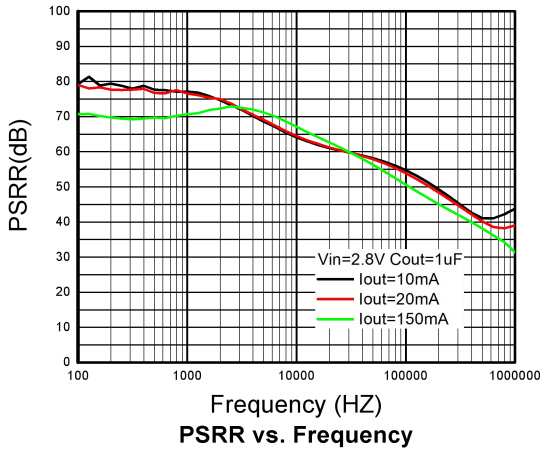

**V<sub>OUT</sub>=2.8V**

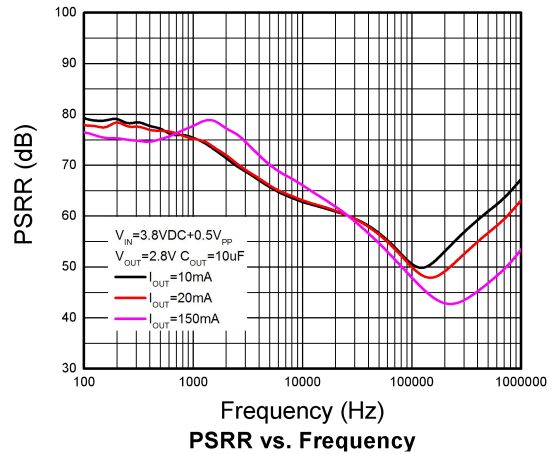
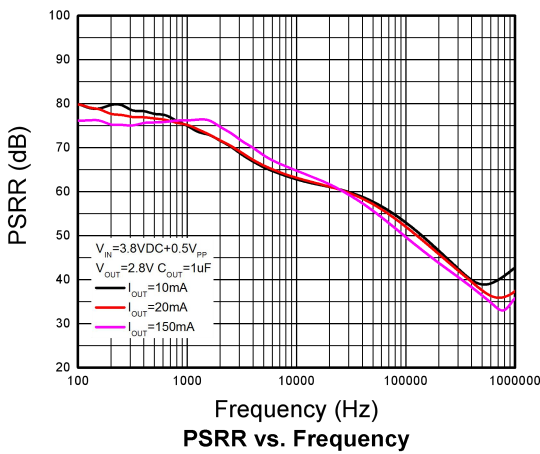



### 1. Start up (Soft Start from EN)

$V_{OUT}=1.2V$

$V_{IN}=2.2V, C_{OUT}=1\mu F, I_{OUT}=10mA$

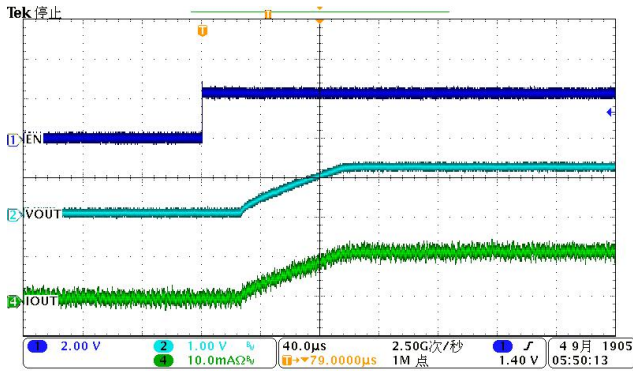

$V_{IN}=2.2V, C_{OUT}=1\mu F, I_{OUT}=250mA$

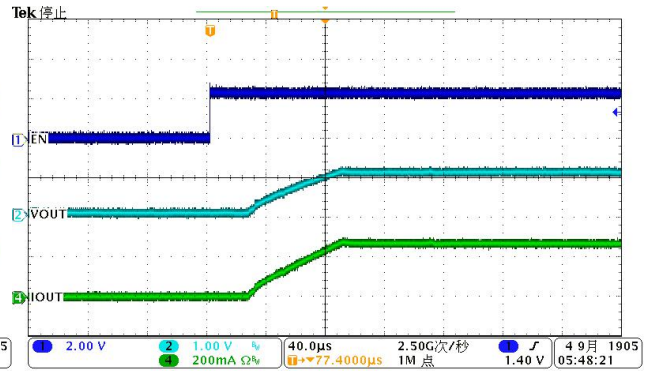

$V_{OUT}=1.8V$

$V_{IN}=2.8V, C_{OUT}=1\mu F, I_{OUT}=10mA$

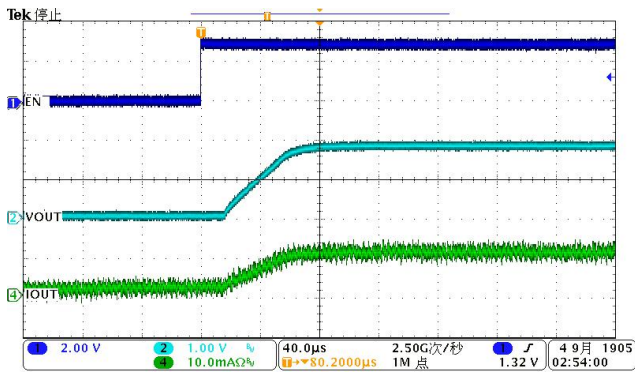

$V_{IN}=2.8V, C_{OUT}=1\mu F, I_{OUT}=300mA$

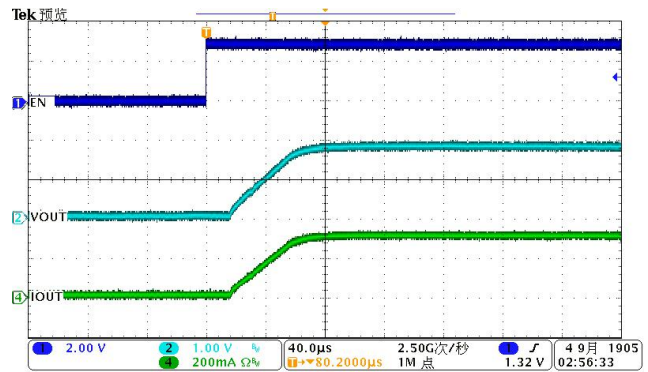

$V_{OUT}=2.8V$

$V_{IN}=3.8V, C_{OUT}=1\mu F, I_{OUT}=10mA$

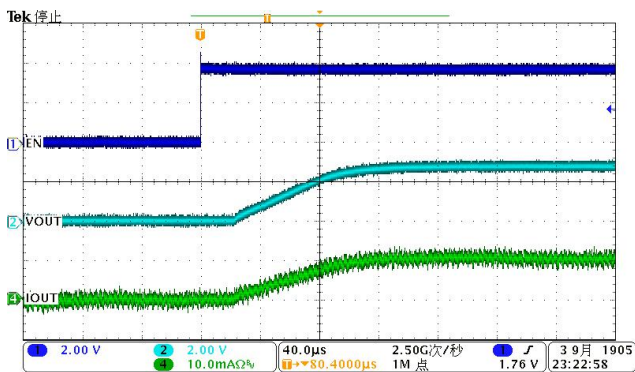

$V_{IN}=3.8V, C_{OUT}=1\mu F, I_{OUT}=300mA$

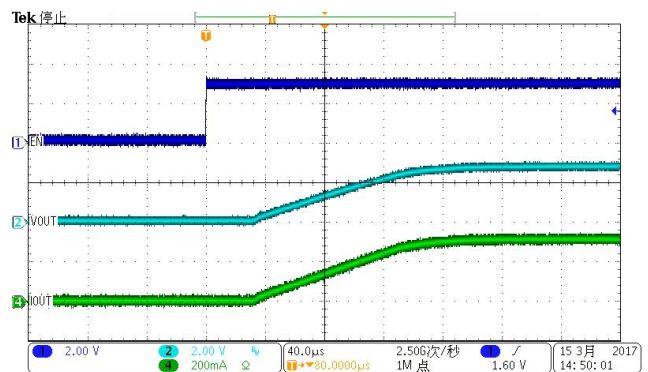

## 2.Shutdown (Shutdown from EN)

$V_{OUT}=1.2V$

$V_{IN}=2.2V, C_{OUT}=1\mu F, I_{OUT}=10mA$

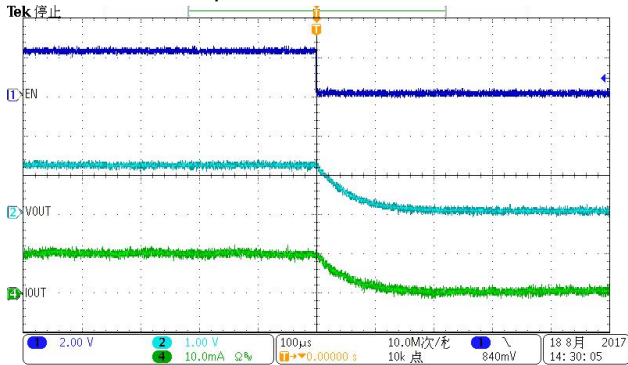

$V_{IN}=2.2V, C_{OUT}=1\mu F, I_{OUT}=300mA$

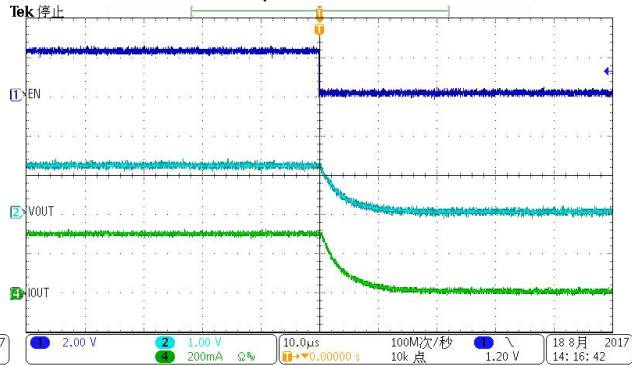

$V_{OUT}=1.8V$

$V_{IN}=2.8V, C_{OUT}=1\mu F, I_{OUT}=10mA$

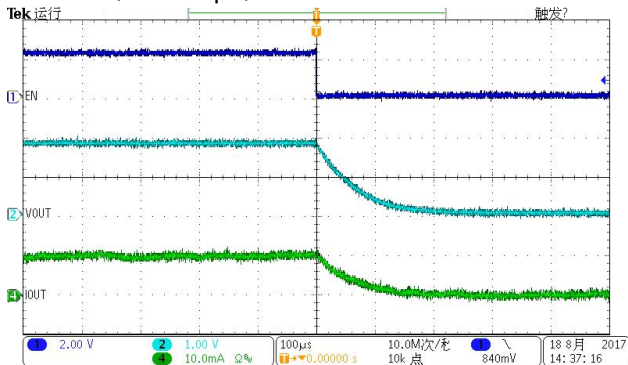

$V_{IN}=2.8V, C_{OUT}=1\mu F, I_{OUT}=300mA$

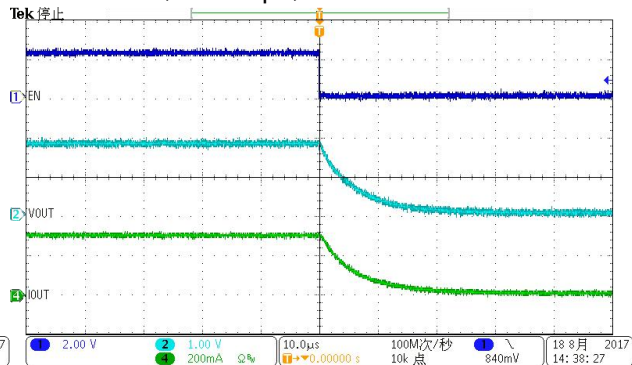

$V_{OUT}=2.8V$

$V_{IN}=3.8V, C_{OUT}=1\mu F, I_{OUT}=10mA$

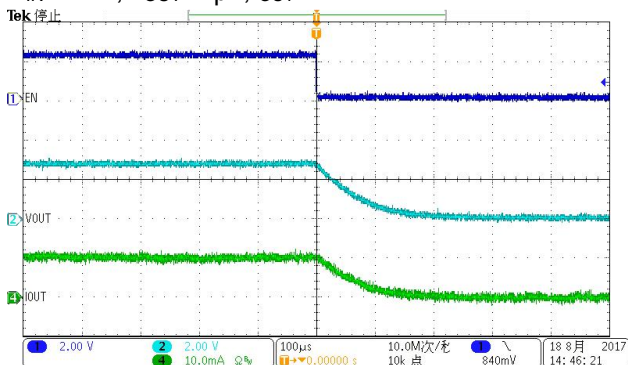

$V_{IN}=3.8V, C_{OUT}=1\mu F, I_{OUT}=300mA$

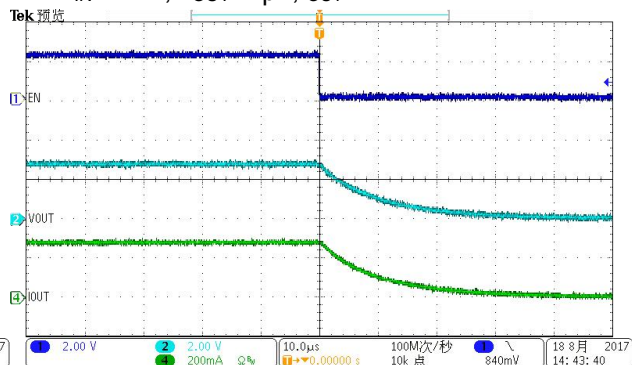

### 3. Load & Line Transient

#### Load step

$V_{OUT}=1.2V$

$V_{IN}=2.2V, C_{OUT}=1\mu F, I_{OUT}=1mA-200mA$  in  $1\mu s$

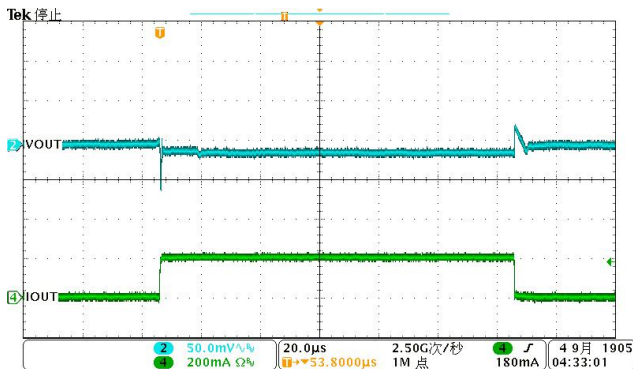

#### Line Step

$V_{IN}=2.2V-3.2V$  in  $20\mu s, C_{OUT}=1\mu F, I_{OUT}=1mA$

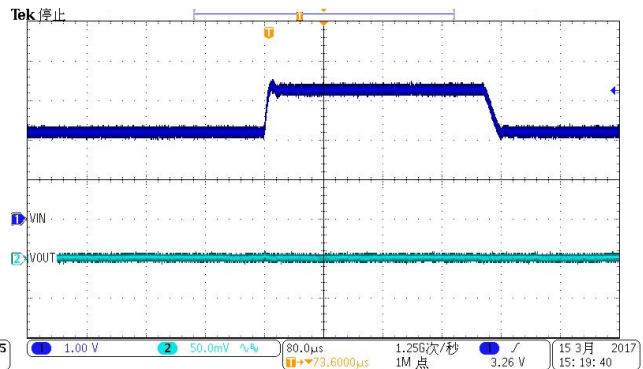

$V_{OUT}=1.8V$

$V_{IN}=2.8V, C_{OUT}=1\mu F, I_{OUT}=1mA-300mA$  in  $1\mu s$

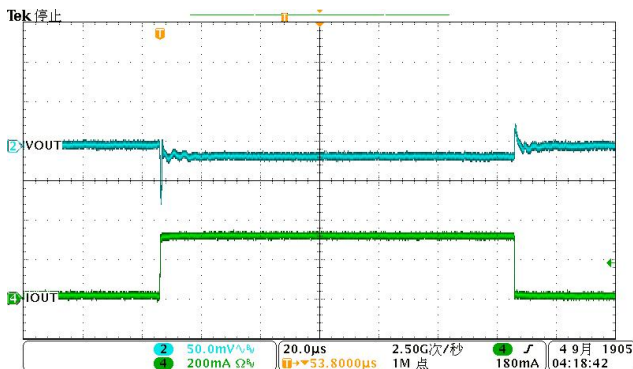

$V_{IN}=2.8V-3.8V$  in  $20\mu s, C_{OUT}=1\mu F, I_{OUT}=1mA$

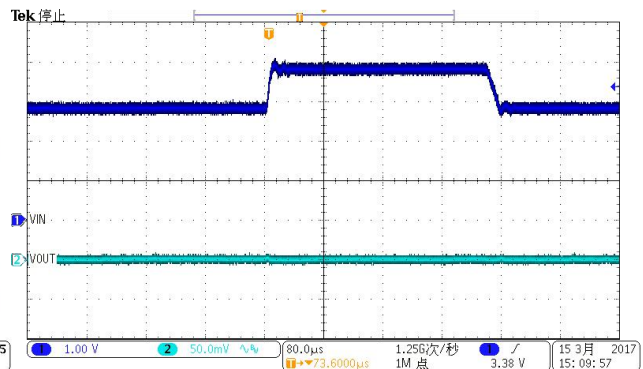

$V_{OUT}=2.8V$

$V_{IN}=3.8V, C_{OUT}=1\mu F, I_{OUT}=1mA-300mA$  in  $1\mu s$

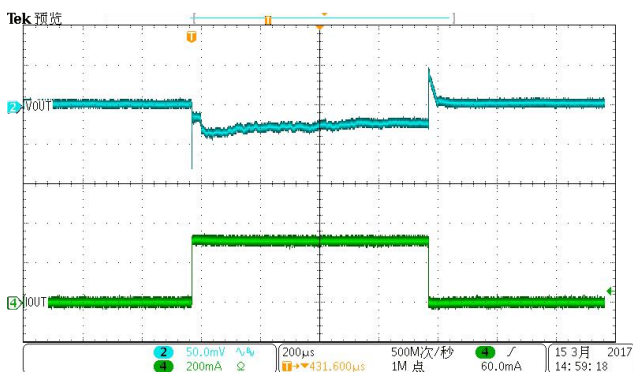

$V_{IN}=3.8V-4.8V$  in  $20\mu s, C_{OUT}=1\mu F, I_{OUT}=1mA$

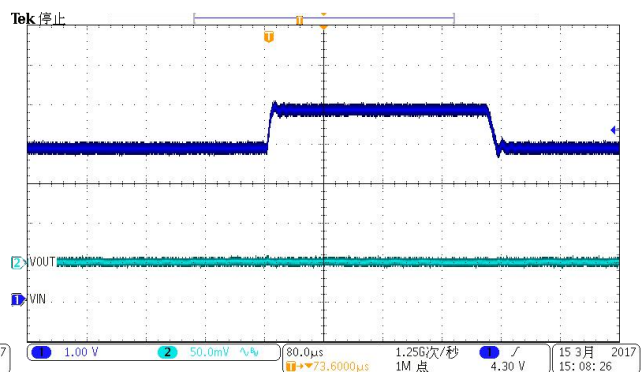

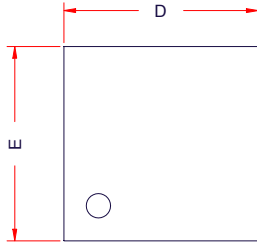
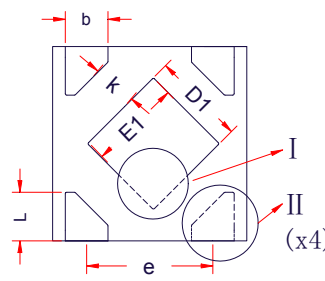
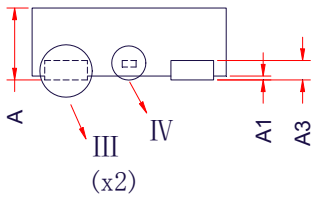
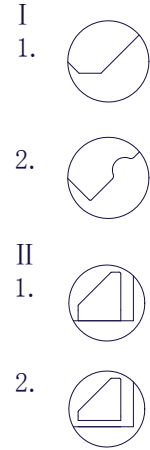
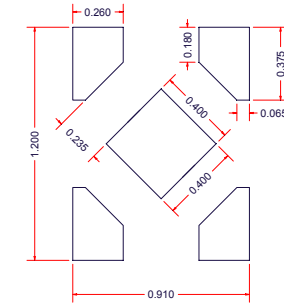
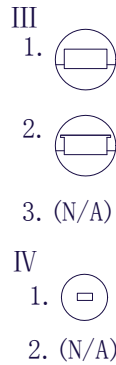
**PACKAGE OUTLINE DIMENSIONS**
**DFN1x1-4L**

**TOP VIEW**

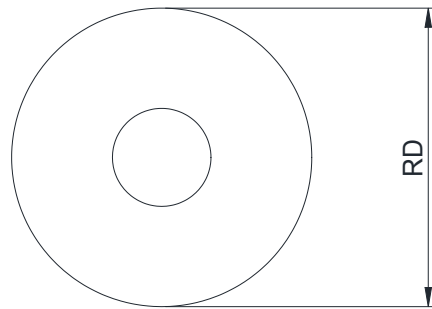
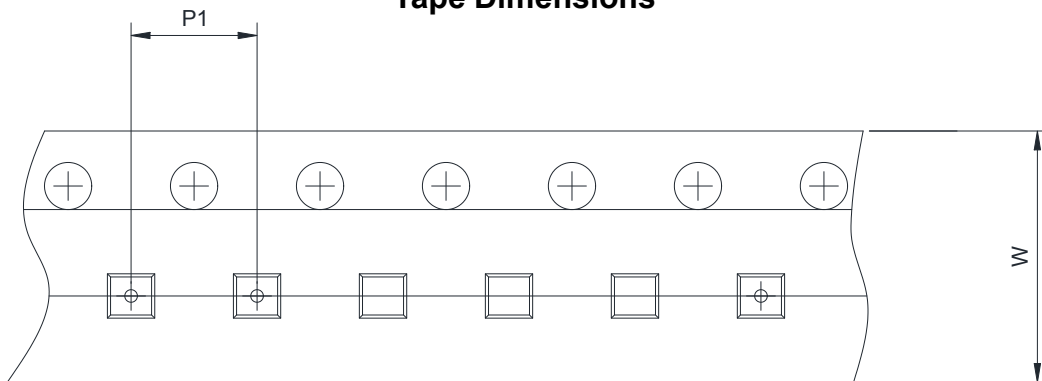
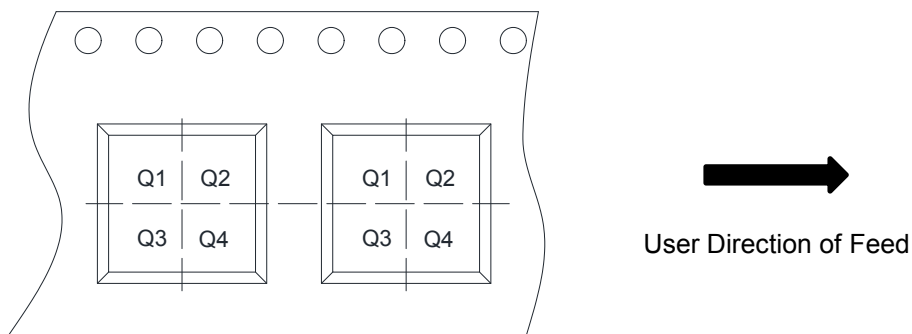
**BOTTOM VIEW**

**SIDE VIEW**

**RECOMMENDED LAND PATTERN (Unit:mm)**

Symbol	Dimensions in Millimeters		
	Min.	Typ.	Max.
A	0.32	0.37	0.42
A1	-	-	0.05
A3	0.10 Ref.		
b	0.17	0.22	0.28
L	0.17	-	0.30
D	0.95	1.00	1.05
E	0.95	1.00	1.05
D1	0.43	0.48	0.54
E1	0.43	0.48	0.54
K	0.14	-	-
e	0.65BSC		

**TAPE AND REEL INFORMATION**
**Reel Dimensions**

**Tape Dimensions**

**Quadrant Assignments For PIN1 Orientation In Tape**

RD	Reel Dimension	<input checked="" type="checkbox"/> 7inch	<input type="checkbox"/> 13inch
W	Overall width of the carrier tape	<input checked="" type="checkbox"/> 8mm	<input type="checkbox"/> 12mm <input type="checkbox"/> 16mm
P1	Pitch between successive cavity centers	<input checked="" type="checkbox"/> 2mm	<input type="checkbox"/> 4mm <input type="checkbox"/> 8mm
Pin1	Pin1 Quadrant	<input checked="" type="checkbox"/> Q1	<input type="checkbox"/> Q2 <input type="checkbox"/> Q3 <input type="checkbox"/> Q4

## ORDER INFORMATION

Ordering No.	Vout (V)	Package	Operating Temperature	Marking	Shipping
WL2836D08-4/TR	0.8	DFN1x1-4L	-40~+85°C	Ih YW	Tape and Reel, 10000
WL2836D09-4/TR	0.9	DFN1x1-4L	-40~+85°C	IA YW	Tape and Reel, 10000
WL2836D10-4/TR	1.0	DFN1x1-4L	-40~+85°C	IB YW	Tape and Reel, 10000
WL2836D105-4/TR	1.05	DFN1x1-4L	-40~+85°C	IC YW	Tape and Reel, 10000
WL2836D11-4/TR	1.1	DFN1x1-4L	-40~+85°C	ID YW	Tape and Reel, 10000
WL2836D12-4/TR	1.2	DFN1x1-4L	-40~+85°C	IE YW	Tape and Reel, 10000
WL2836D15-4/TR	1.5	DFN1x1-4L	-40~+85°C	IG YW	Tape and Reel, 10000
WL2836D18-4/TR	1.8	DFN1x1-4L	-40~+85°C	IH YW	Tape and Reel, 10000
WL2836D25-4/TR	2.5	DFN1x1-4L	-40~+85°C	IK YW	Tape and Reel, 10000
WL2836D27-4/TR	2.7	DFN1x1-4L	-40~+85°C	IY YW	Tape and Reel, 10000
WL2836D28-4/TR	2.8	DFN1x1-4L	-40~+85°C	IL YW	Tape and Reel, 10000
WL2836D29-4/TR	2.9	DFN1x1-4L	-40~+85°C	Ig YW	Tape and Reel, 10000
WL2836D30-4/TR	3.0	DFN1x1-4L	-40~+85°C	IM YW	Tape and Reel, 10000
WL2836D33-4/TR	3.3	DFN1x1-4L	-40~+85°C	IN YW	Tape and Reel, 10000