

# WD3136E

## 24V DC/DC Step-Up Regulator

### Descriptions

The WD3136E is a high efficiency, high power, peak current mode step-up converter integrated 32V power MOSFET with 3A (Typ.) current limit. It could support up to maximum 24V output.

The boost converter WD3136E runs in Pulse-Width Modulation (PWM) mode at 1MHz fixed switching frequency to reduce output ripple and improve conversion efficiency. It allows for the use of small external components. At light load, the converter enters Skipping Mode to maintain a high efficiency over a wide load current range. The build-in soft start circuitry minimizes the inrush current at start-up.

The WD3136E is available in SOT-23-6L package. Standard product is Pb-free and Halogen-free.

### Features

- Input Voltage Range : 2.4V~20V
- Reference Voltage : 600mV
- Switching Frequency : 1MHz (Typ.)
- Efficiency : Up to 94%
- Internal Compensation
- Current Limit : 3A (D=50%)
- Low R<sub>DS(ON)</sub> : 100mΩ
- Automatic Pulse Skipping Modulation
- Package : SOT-23-6L

### Applications

- Cell Phone and Smart Phone
- PDA, PMP, MP3
- Digital Camera

[Http://www.ovt.com](http://www.ovt.com)



**SOT-23-6L**

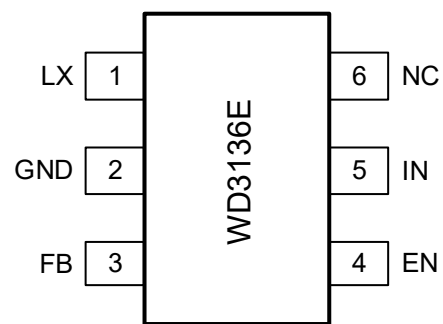

**Pin Configuration (Top View)**

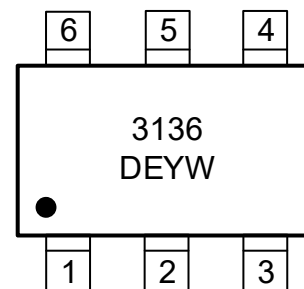

3136 = Device code  
 DE = Special code  
 Y = Year code  
 W = Week code

### Marking

### Order Information

Device	Package	Shipping
WD3136E-6/TR	SOT-23-6L	3000/Reel & Tape

Typical Applications

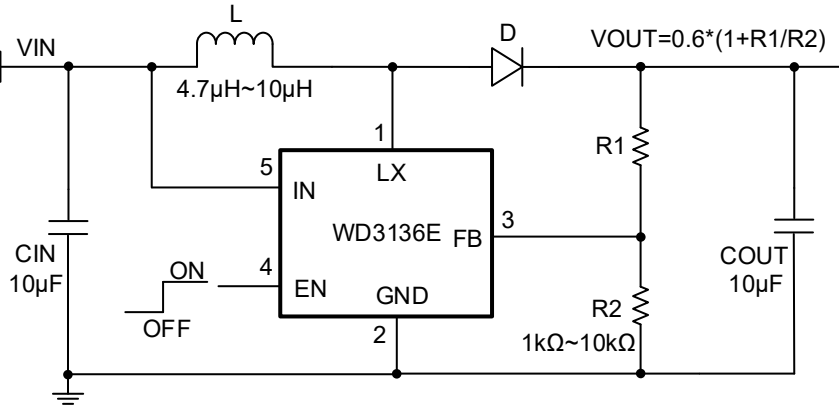

Pin Descriptions

Symbol	Pin No.	Descriptions
LX	1	Switch Node
GND	2	Ground
FB	3	Feedback
EN	4	Enable
IN	5	Power Supply
NC	6	No Connection

Block Diagram

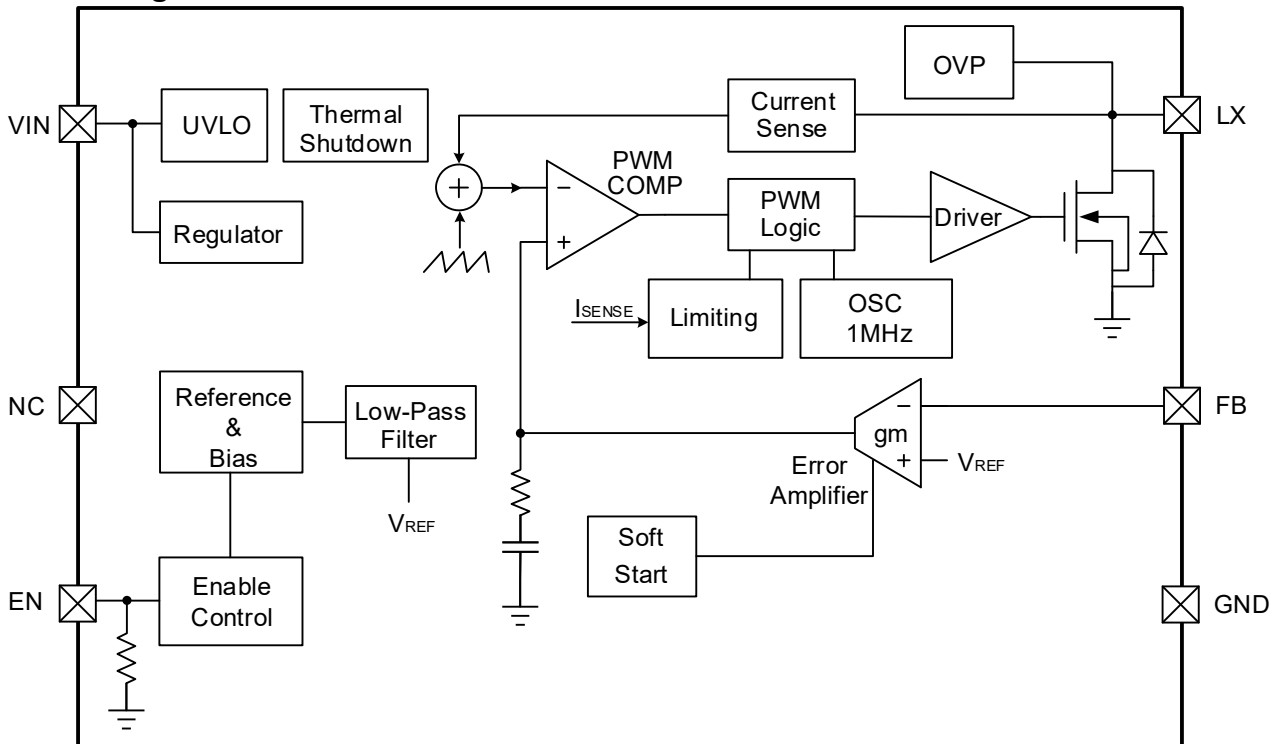

## Absolute Maximum Ratings

Parameter	Symbol	Value	Unit
VIN Pin Voltage Range	V <sub>IN</sub>	-0.3~28	V
EN Pin Voltage Range	V <sub>EN</sub>	-0.3~28	V
LX Pin Voltage Range (DC)	V <sub>LX</sub>	-0.3~32	V
FB Pin Voltage Range	V <sub>FB</sub>	-0.3~6	V
Junction To Ambient Thermal Resistance – SOT-23-6L (Note 1)	R <sub>θJA</sub>	90	°C/W
Operating Junction Temperature	T <sub>J</sub>	-40~150	°C
Lead Temperature(Soldering, 10s)	T <sub>L</sub>	260	°C
Storage Temperature	T <sub>stg</sub>	-55~150	°C

These are stress ratings only. Stresses exceeding the range specified under “Absolute Maximum Ratings” may cause substantial damage to the device. Functional operation of this device at other conditions beyond those listed in the specification is not implied and prolonged exposure to extreme conditions may affect device reliability.

**Note 1:** Thermal Resistance (θ<sub>JA</sub>) is measured with the component mounted on 1.5inch x 1.5inch, 2layers, FR4 test board with 1.0inch x 1.0inch copper area of 2oz in top layer, and in still air condition.

## ESD Ratings

Parameter	Symbol	Value	Unit
Electrostatic Discharge	HBM	4000	V
	CDM	2000	V

## Recommended Operating Conditions

Parameter	Symbol	Value	Unit
Input Voltage Range	V <sub>IN</sub>	2.4~20	V
Output Voltage Range	V <sub>OUT</sub>	V <sub>IN</sub> ~24	V
Inductor	L	4.7~10	μH
Input Capacitor	C <sub>IN</sub>	10 (Typ.)	μF
Output Capacitor	C <sub>OUT</sub>	10 (Typ.)	μF
Resistance Between FB Pin And GND	R <sub>2</sub>	1~10	kΩ
Operating Ambient Temperature	T <sub>A</sub>	-40~85	°C
Operating Junction Temperature	T <sub>J</sub>	-40~125	°C

These values are recommended values that have been successfully tested in several applications. Other values may be acceptable in other applications but should be fully tested by the user.

## Electronics Characteristics

(Ta=25 °C, VIN=3V, L=4.7μH, CIN=COUT=10μF, unless otherwise noted)

Parameter	Symbol	Test Condition	Min	Typ	Max	Units
<b>Basic Operation</b>						
Operation Voltage Range	V <sub>IN</sub>		2.4		20	V
Under Voltage Lockout	V <sub>UVLO</sub>	V <sub>IN</sub> Rising		2.2	2.39	V
UVLO Hysteresis	V <sub>HYS</sub>			0.1		V
Quiescent Current	I <sub>Q</sub>	No Switching V <sub>FB</sub> =0.7V		0.25		mA
Supply Current	I <sub>S</sub>	Switching at no load		0.5		mA
Shutdown Current	I <sub>SD</sub>	V <sub>EN</sub> <0.4V		0.05	1	μA
<b>Enable Control</b>						
Enable Low Voltage	V <sub>ENL</sub>				0.4	V
Enable High Voltage	V <sub>ENH</sub>		1.5			V
EN Pull-down Resistance	R <sub>EN</sub>			1.8		MΩ
EN Shutdown Delay	t <sub>SHDN, EN</sub>			0.12		ms
<b>Voltage And Current Control</b>						
Operation Frequency	f <sub>OSC</sub>		0.8	1	1.2	MHz
Maximum Duty Cycle	D <sub>MAX</sub>			91		%
Feedback Reference	V <sub>FB</sub>		0.588	0.6	0.612	V
Feedback Input Bias Current	I <sub>FB</sub>			0.1	1	μA
<b>Power Switch</b>						
On Resistance	R <sub>ON</sub>	I <sub>LX</sub> =1A		0.1		Ω
Main Switch Leakage Current	I <sub>LN_MS</sub>	V <sub>LX</sub> =32V, Disable		0.1	1	μA
Current Limit	I <sub>LIM</sub>	D=50%		3		A
<b>Protection</b>						
Thermal Shutdown	T <sub>SD</sub>			160		°C
T <sub>SD</sub> Hysteresis	T <sub>SD-HYS</sub>			30		°C

**Typical Characteristics** ( $T_a=25^\circ\text{C}$ ,  $L=4.7\mu\text{H}$ ,  $C_{IN}=C_{OUT}=10\mu\text{F}$ , unless otherwise noted)

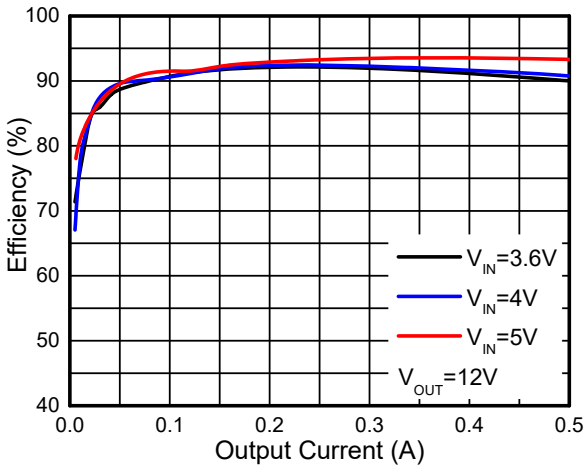

**Efficiency vs. Output Current**

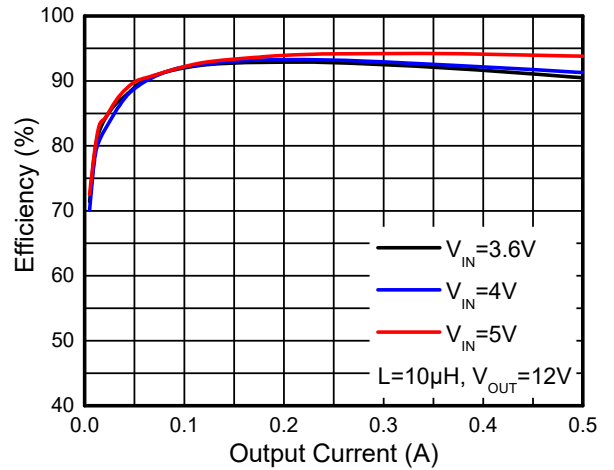

**Efficiency vs. Output Current**

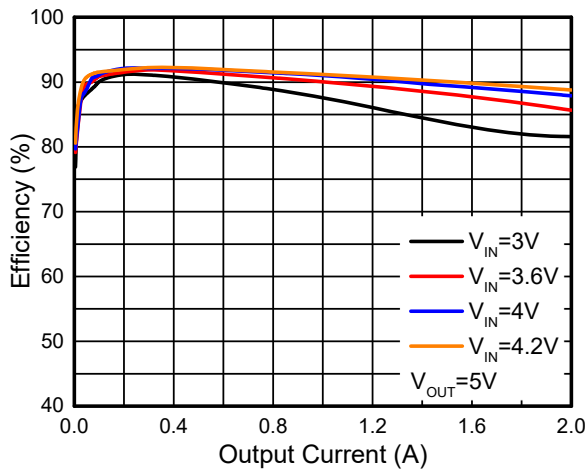

**Efficiency vs. Output Current**

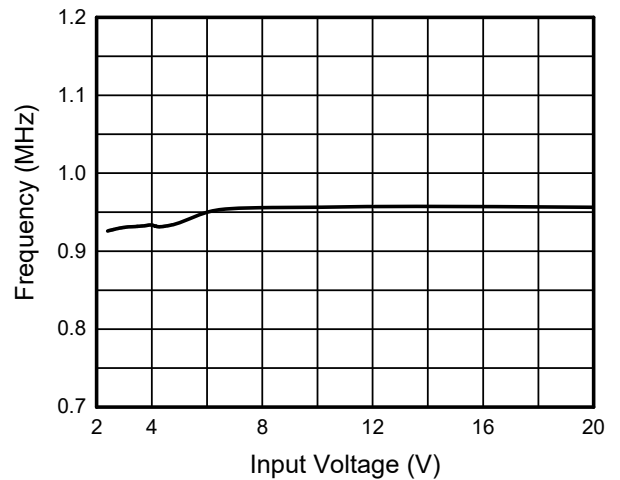

**Frequency vs. Input Voltage**

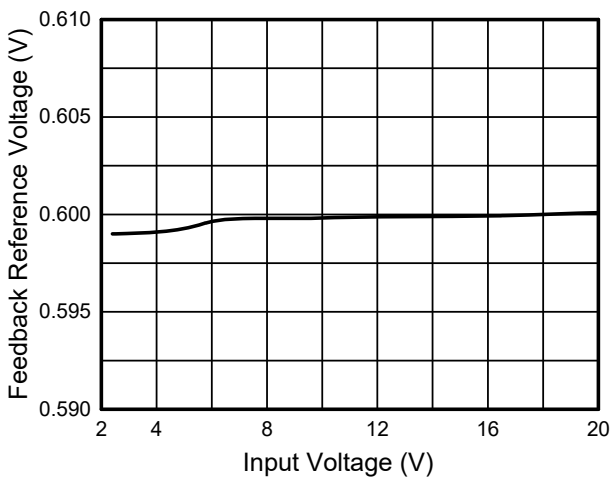

**Feedback Reference Voltage vs. Input Voltage**

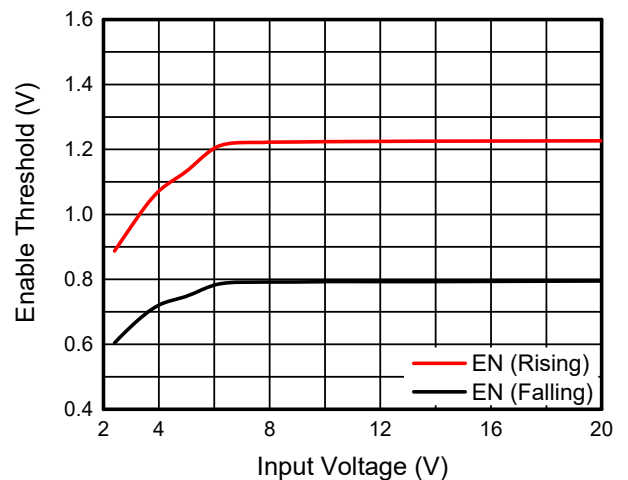

**Enable Threshold vs. Input Voltage**

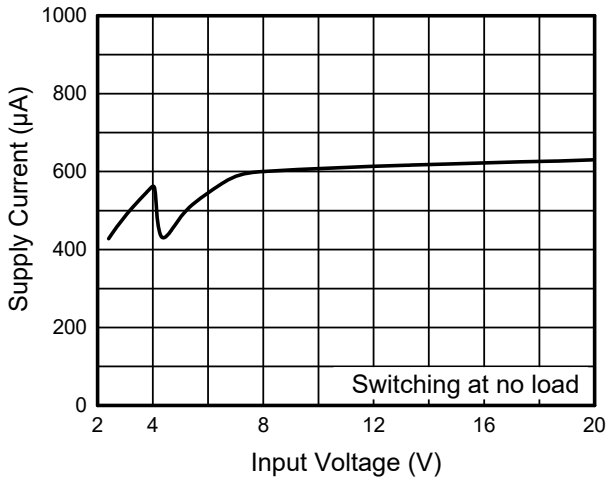

Supply Current vs. Input Voltage

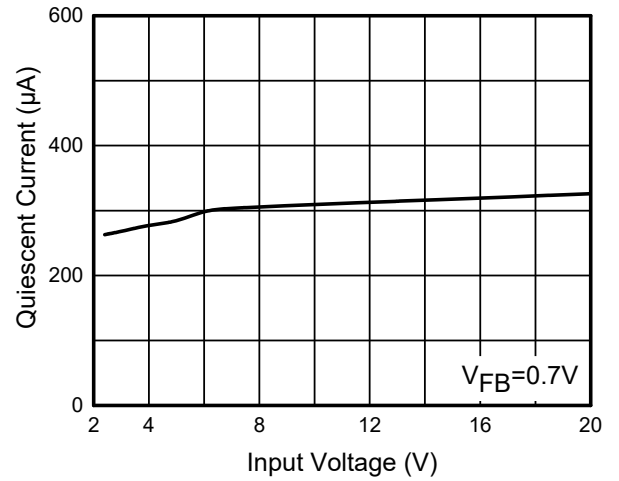

Quiescent Current vs. Input Voltage

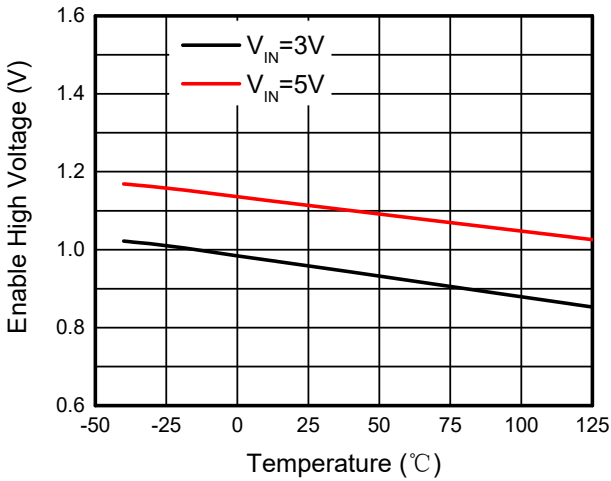

Enable High Voltage vs. Temperature

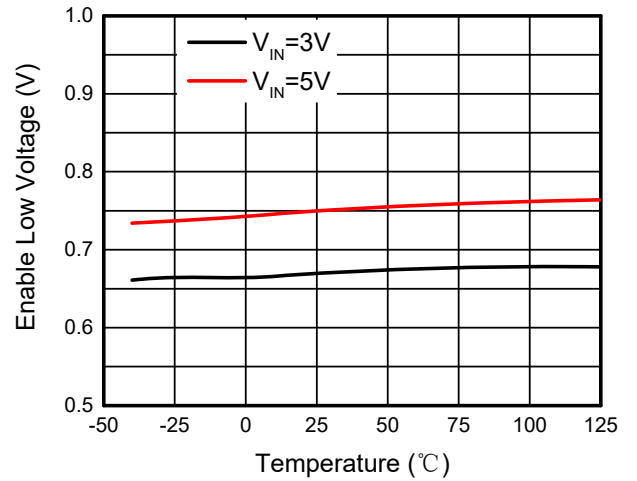

Enable Low Voltage vs. Temperature

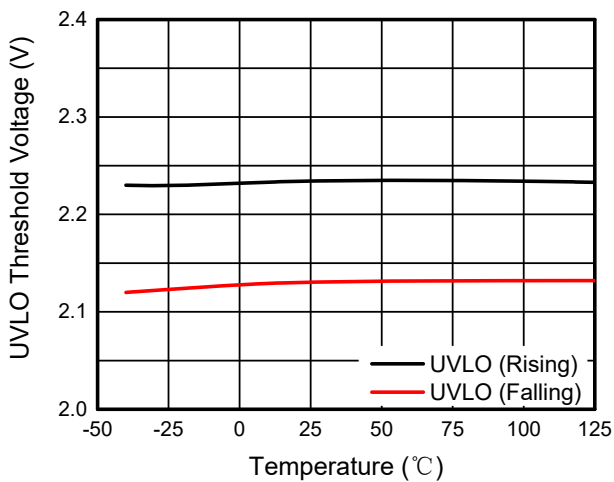

UVLO Threshold Voltage vs. Temperature

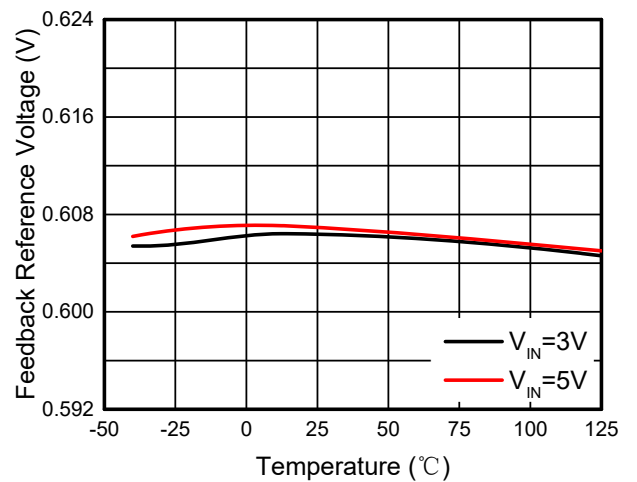

Feedback Reference Voltage vs. Temperature

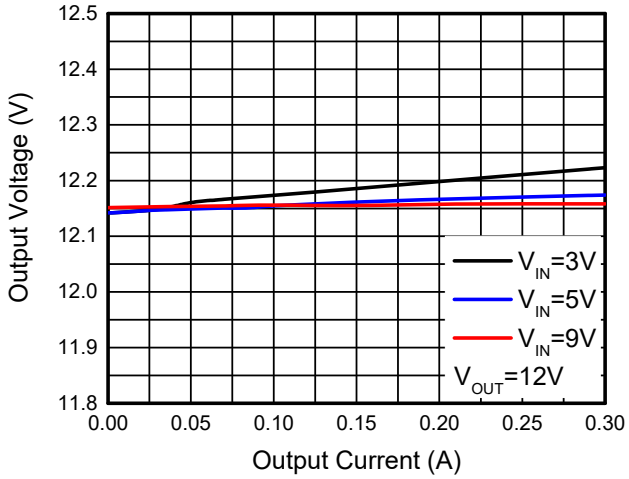

Output Voltage vs. Output Current

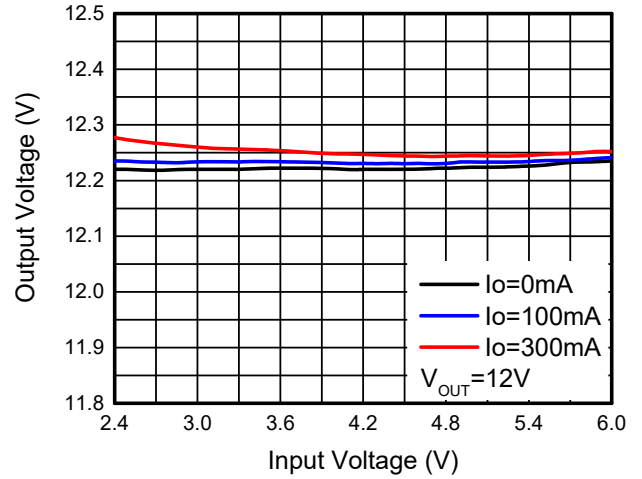

Output Voltage vs. Input Voltage

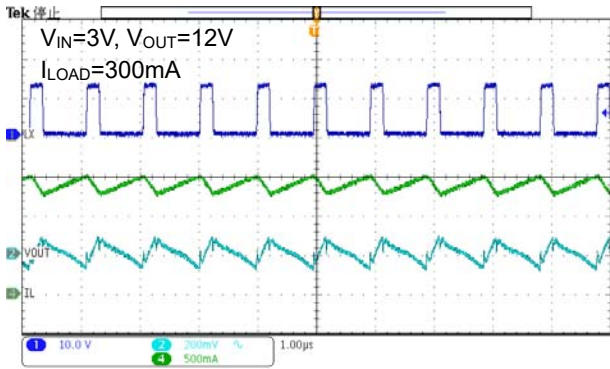

Operation Waveforms

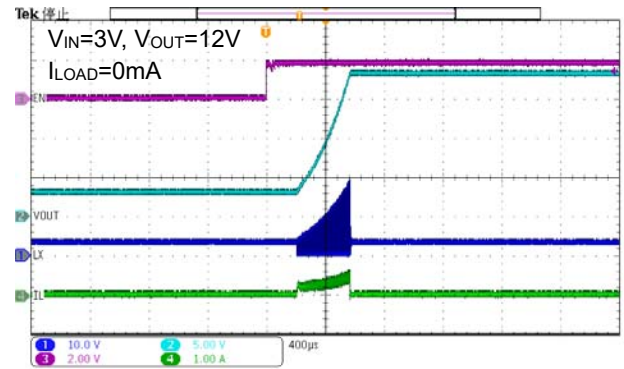

Output Open Circuit Protection

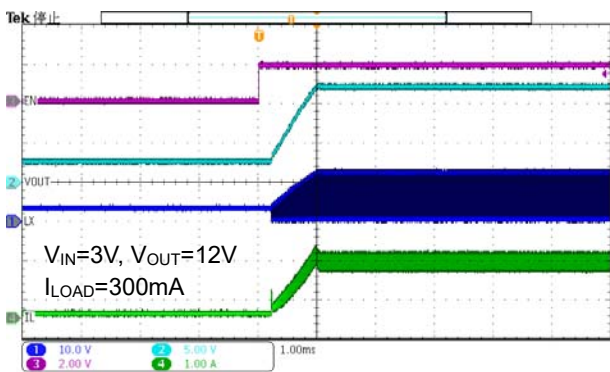

Start-Up From EN

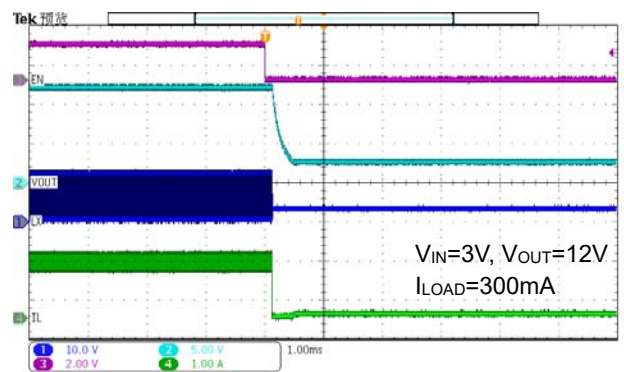

Shut-Down From EN



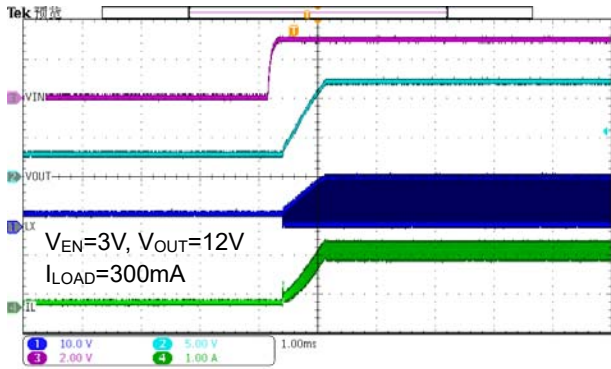

Start-Up From IN

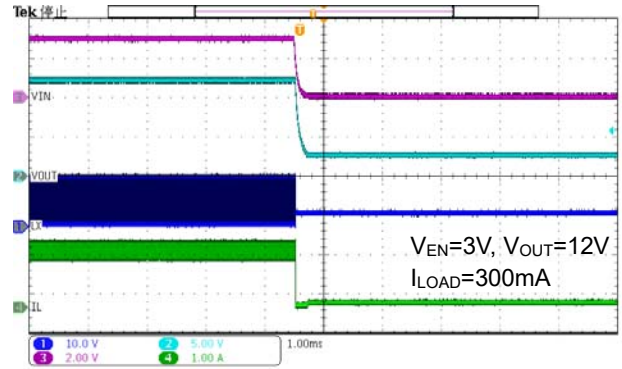

Shut-Down From IN

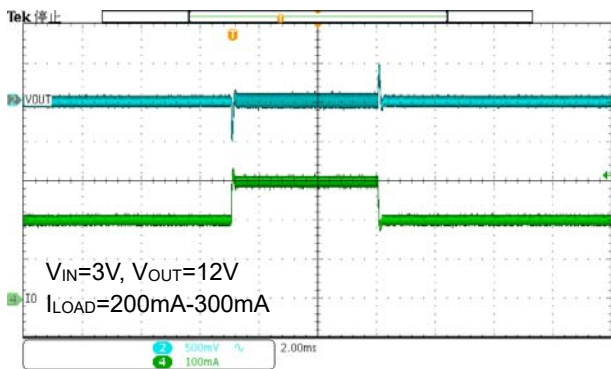

Load Transient Response



## Operation Information

### Normal Operation

The WD3136E is a high efficiency, high output voltage boost converter. The device uses a fixed frequency, peak current mode boost regulator architecture to regulate voltage at the feedback pin. The device integrates 32V/3A switch MOSFET. The operation of the WD3136E can be understood by referring to the block diagram. The beginning of each cycle turns on the Power MOSFET. A slope compensation ramp is added to output of the current sense amplifier and the result is fed into the negative input of the comparator (COMP). When this voltage goes above the output voltage of the error amplifier (EA), the Power MOSFET is turned off. The FB voltage can be regulated to the reference voltage of bandgap with EA block. The feedback loop regulates the FB pin to a low reference voltage (600mV Typ.). The WD3136E has internal soft start to limit the amount of input current at startup and to also limit the amount of overshoot on the output.

### Cycle-By-Cycle Current Limit

The WD3136E uses a cycle-by-cycle current limit circuitry to limit the inductor peak current in the event of an overload condition. The current flow through inductor in charging phase is detected by a current sensing circuit. As the value comes across the current limiting threshold the power MOSFET turns off, so that the inductor will be forced to leave charging stage and enter discharging stage. Therefore, the inductor current will not increase over the current limiting threshold.

### Output Open Circuit Protection

Output open circuit protection circuitry prevents IC damage as the result of output open circuit. The WD3136E monitors the voltage at the LX pin and FB pin during each switching cycle. The circuitry turns off the switch MOSFET and shuts down the IC when both of the following conditions persist for 4 switching clock cycles: (1) the LX voltage exceeds the set

threshold voltage and (2) the FB voltage is less than 50mV. Then, the WD3136E turns off the power switch MOSFET and shuts down IC until EN or power supply is recycled to enable IC.

### UVLO Protection

To avoid malfunction of the WD3136E at low input voltages, an under voltage lockout is included that disables the device, until the input voltage exceeds 2.2V (Typ.).

### Shutdown Mode

Drive EN to GND to place the WD3136E in shutdown mode. In shutdown mode, the reference, control circuit, and the main switch turn off. Input current falls to smaller than 1 $\mu$ A during shutdown mode.

### Over-Temperature-Protection (OTP)

As soon as the junction temperature ( $T_J$ ) exceeds 160°C (Typ.), the WD3136E goes into thermal shutdown. In this mode, the main power MOSFET is turned off until temperature falls below 130°C (Typ.). Then the device starts switching again.

## Application Information

External component selection for the application circuit depends on the load current requirements. Certain trade-offs between different performance parameters can also be made.

### Output Voltage Setting

The loop of Boost structure will keep the FB pin voltage equal to the reference voltage  $V_{REF}$ . Therefore, when  $R_2$  connects FB pin and GND,  $R_1$  connects OUT pin and FB pin, the output voltage is set externally by using a resistor divider, which is equal to following equation:

$$V_{out} = V_{FB} \times \left(1 + \frac{R_1}{R_2}\right)$$

Where

$V_{OUT}$  = output voltage

$V_{FB}$  = regulated voltage of FB pin

$R_1$  = resistance between OUT pin and FB pin

$R_2$  = resistance between FB pin and GND

The recommended value of  $R_2$  is 1k $\Omega$ ~10k $\Omega$ .

The output current tolerance depends on the  $V_{FB}$  accuracy and the current sensor resistor accuracy.

### Boost Inductor Selection

Small inductance will make the ripple current large and too large inductance will cause poor dynamic characteristics and the slow response. The proper inductance should be selected to ensure the loop stability. For these reasons, the recommended range of inductor value for the application is 4.7 $\mu$ H~10 $\mu$ H.

### Input Capacitor Selection

Connect the input capacitance from the IN pin to the reference ground plane. Input capacitance reduces the ac voltage ripple on the input rail for the boost converter. The rated voltage of capacitor depends on the applied input voltage. The recommended capacitor is a 10 $\mu$ F/50V, X5R or X7R ceramic capacitor.

### Output Capacitor Selection

The output capacitor is mainly selected to meet the

requirements for the output ripple and loop stability. This ripple voltage is related to the capacitor's capacitance and its equivalent series resistance (ESR). The rated voltage of capacitor depends on the applied output voltage. The recommended capacitor is a 10 $\mu$ F/50V, X5R or X7R ceramic capacitor.

### Diode Selection

The rectifier diode supplies current path to the inductor when the internal MOSFET is off. Use a schottky diode with low forward voltage to reduce losses. The diode should be rated for a reverse blocking voltage greater than the output voltage used. The average current rating must be greater than the maximum load current expected, and the peak current rating must be greater than the peak inductor current.

### PCB Layout Considerations

1. Use separated power supply trace and power ground planes from other sensitive blocks.
2. Locate  $C_{IN}$  as close to the IN pin as possible. And connect the  $C_{IN}$ 's GND close to IC's GND.
3. Route the high current path from  $C_{IN}$ , through L to the LX pin and GND as short as possible. And keep high current traces as short and as wide as possible.
4. Route the high current path from L to diode and  $C_{OUT}$  as short as possible. Connect the  $C_{OUT}$ 's GND as close to IC's GND as possible.
5. Avoid routing sensitive trace near this block, especially LX node. Place a ground plane shield between the traces.
6. Place the  $R_2$  resistor as close to FB pin as possible, for the FB pin is a high impedance input pin which is susceptible to noise and high voltage spike.
7. Avoid routing a long OUT or FB trace parallel to other sensitive signal. Place a ground plane shield between the traces.

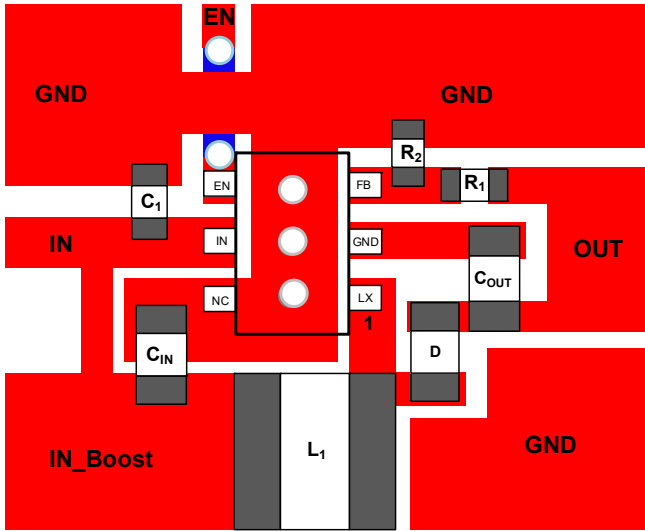
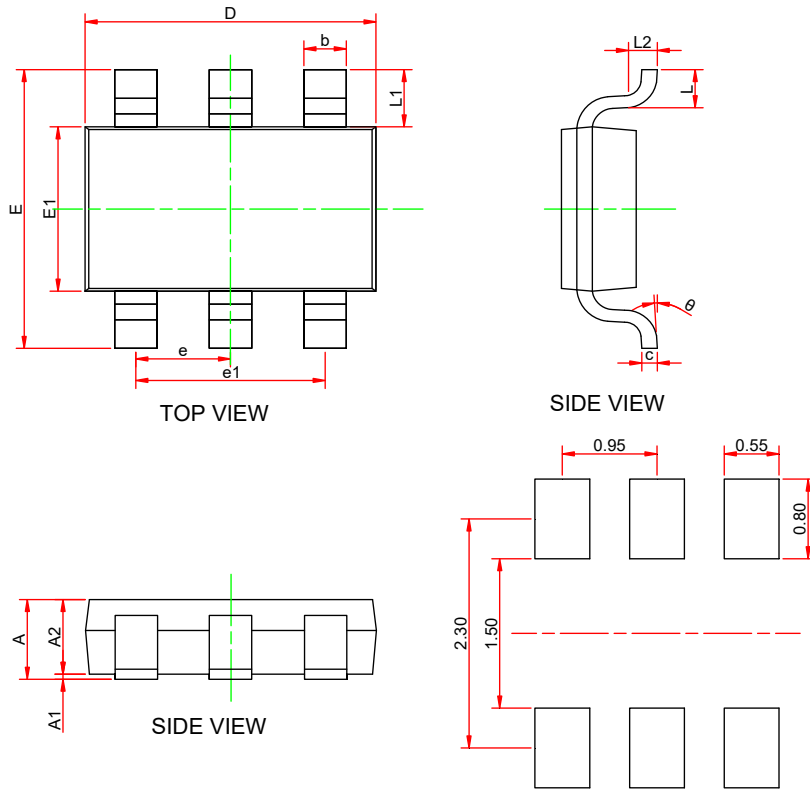

Figure 1: WD3136E PCB Layout

**PACKAGE OUTLINE DIMENSIONS**
**SOT-23-6L**

RECOMMENDED LAND PATTERN(unit:mm)

Symbol	Dimensions in Millimeters		
	Min.	Typ.	Max.
A	-	-	1.25
A1	0	-	0.15
A2	1.00	1.10	1.20
b	0.30	0.40	0.50
c	0.10	-	0.21
D	2.72	2.92	3.12
E	2.60	2.80	3.00
E1	1.40	1.60	1.80
e	0.95BSC		
e1	1.80	1.90	2.00
L	0.30	-	0.60
L1	0.59Ref		
L2	0.25Ref		
$\theta$	0 °	-	8 °

**TAPE AND REEL INFORMATION**

**Reel Dimensions**

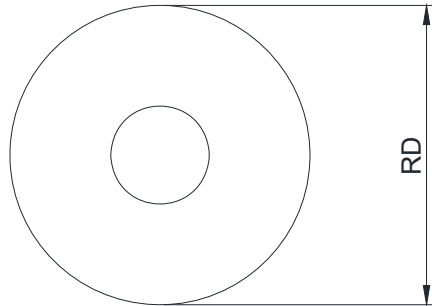

**Tape Dimensions**

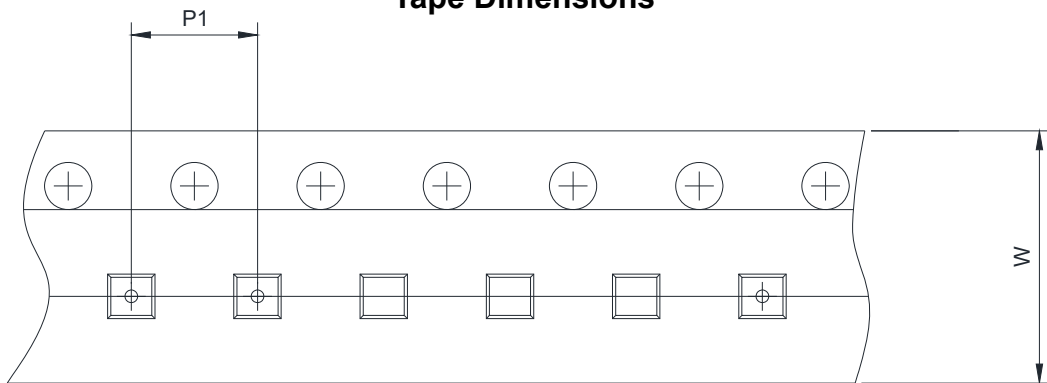

**Quadrant Assignments For PIN1 Orientation In Tape**

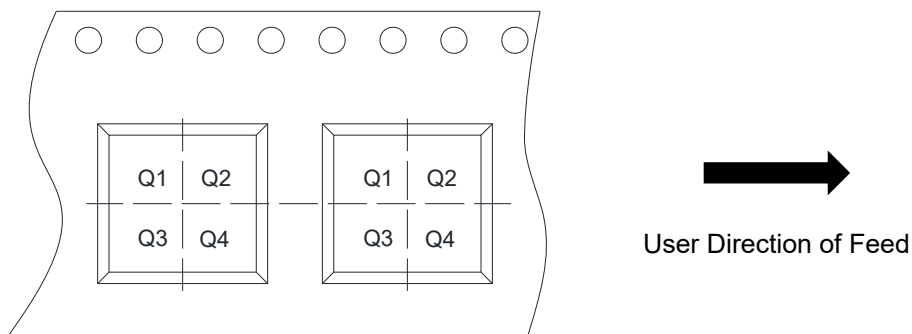

RD	Reel Dimension	<input checked="" type="checkbox"/> 7inch	<input type="checkbox"/> 13inch
W	Overall width of the carrier tape	<input checked="" type="checkbox"/> 8mm	<input type="checkbox"/> 12mm <input type="checkbox"/> 16mm
P1	Pitch between successive cavity centers	<input type="checkbox"/> 2mm	<input checked="" type="checkbox"/> 4mm <input type="checkbox"/> 8mm
Pin1	Pin1 Quadrant	<input type="checkbox"/> Q1	<input type="checkbox"/> Q2 <input checked="" type="checkbox"/> Q3 <input type="checkbox"/> Q4